

Nom i Cognoms: \_\_\_\_\_ Data: \_\_\_\_\_  
Codi client: \_\_\_\_\_ Venedor: \_\_\_\_\_ Ascensor: \_\_\_\_\_ Fulla nº: \_\_\_\_\_

Base  Douglas Clar  W1000ST9 (blanco premium)  Altres: \_\_\_\_\_

Color 1  U732ST15 (Macadan)  U727ST9 (Argila)  Altres: \_\_\_\_\_

Bressol-llit 140x70 (mides ext. 146x77x98)

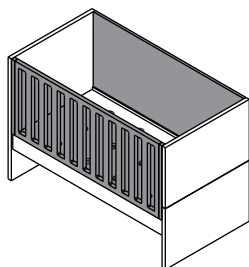

Transformable

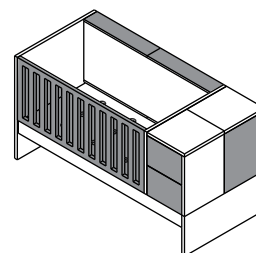

- 140x70-180x80 mides ext. 188x88x98
- 135x80-190x90 mides ext. 198x98x98

Llit 140x70 (mides ext. 146x77x98)

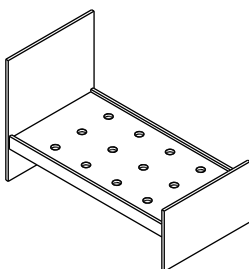

Llit

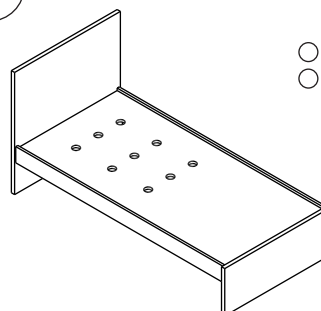

- 180x80 mides ext. 188x88x98
- 190x90 mides ext. 198x98x98

Calaix inferior/llit-niu

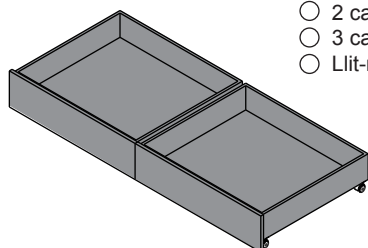

- 1 calaix(bressol-llit)
- 2 calaixos (transformable)
- 3 calaixos (transformable)
- Llit-niu (transformable)

- Amb rodes
- Amb guies

Caviador/pissarra

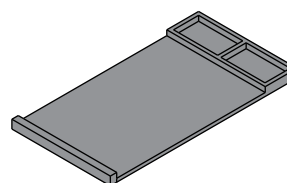

Observacions generals:

Conforme client

Nom i Cognoms: \_\_\_\_\_ Data: \_\_\_\_\_  
Codi client: \_\_\_\_\_ Venedor: \_\_\_\_\_ Ascensor: \_\_\_\_\_ Fulla nº: \_\_\_\_\_

Base  Douglas Clar  W1000ST9 (blanco premium)  Altres: \_\_\_\_\_

Color 1  U732ST15 (Macadan)  U727ST9 (Argila)  Altres: \_\_\_\_\_

Prestatgeria  Prestatgeria-penjador  Prestatgeria de barana

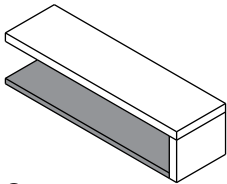

- 50x20x18  70x20x18  100x20x18
- Obertura:  
 Dreta  Esquerre

Prestatgeria-penjador

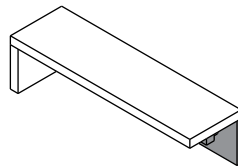

- 50x20x18  70x20x18
- Obertura:  
 Dreta  Esquerre

Prestatgeria de barana

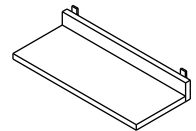

Calaixera  Xinfonier  Mòdul Alt

- 3 calaixos 110x60x78  
 3 calaixos+porta 120x60x78  
 4 calaixos 110x60x90  
 4 calaixos+porta 120x60x90

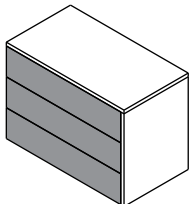

- Porta:  
 Dreta  Esquerre

Xinfonier

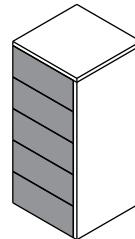

- 5 calaixos 55x55x120  
 6 calaixos 55x55x140

Mòdul Alt

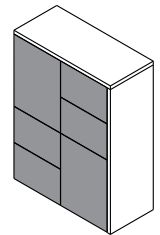

- 4 calaixos+2portes 90x45x120  
 4 calaixos+2portes 120x45x120

Llitera

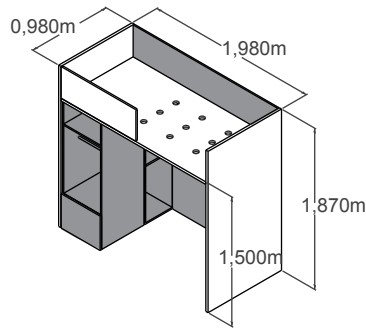
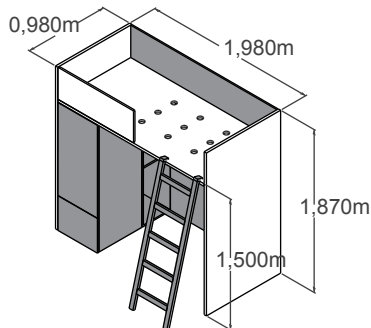

Canviador de calaixera  
[Mida.Ext. 72x50x16 CM]

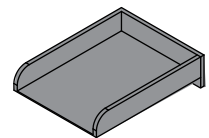

- Altres mides \_\_\_\_\_  
(mida espuma)

Observacions generals:

Conforme client

Nom i Cognoms: \_\_\_\_\_ Data: \_\_\_\_\_  
Codi client: \_\_\_\_\_ Venedor: \_\_\_\_\_ Ascensor: \_\_\_\_\_ Fulla nº: \_\_\_\_\_

Base  Douglas Clar  W1000ST9 (blanco premium)  Altres: \_\_\_\_\_  
Color 1  U732ST15 (Macadan)  U727ST9 (Argila)  Altres: \_\_\_\_\_

Armaris portes abatibles

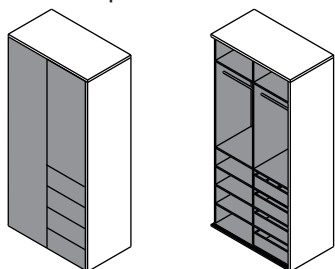

2A4 110x60x230  
2 cossos; portes abatibles; 4 calaixos

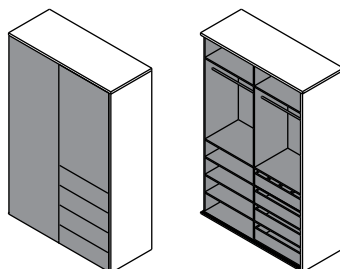

2A4 150x60x230  
2 cossos; portes abatibles; 4 calaixos

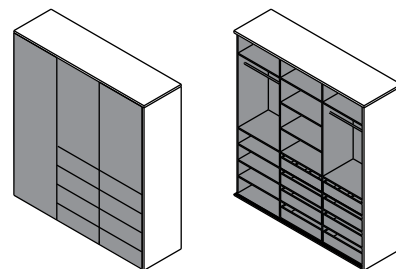

3A8 210x60x230  
3 cossos; portes abatibles; 8 calaixos

Armaris portes corraderes

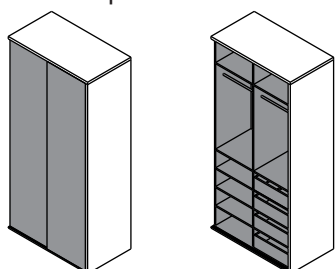

2C4 110x60x230  
2 cossos; portes corraderes; 4 calaixos

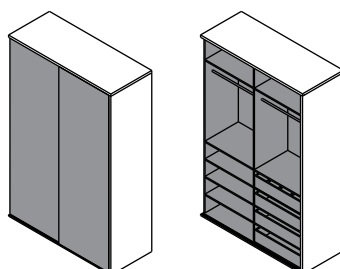

2C4 150x60x230  
2 cossos; portes corraderes; 4 calaixos

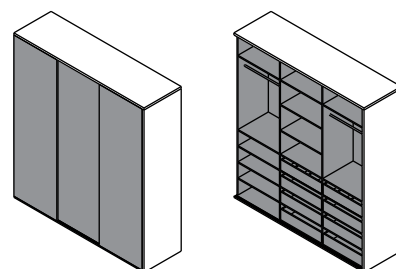

3C8 210x60x230  
3 cossos; portes corraderes; 8 calaixos

Armaris cantoners

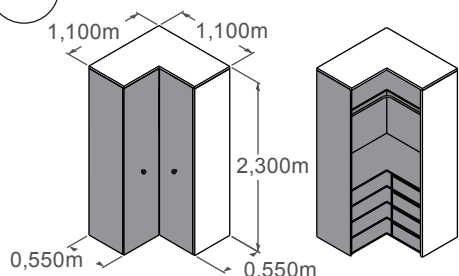

2A4L 110x110x230  
2 cossos; portes abatibles; 4 calaixos; forma L

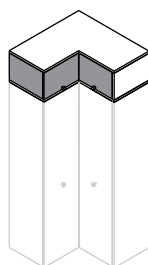

Altell 2AL

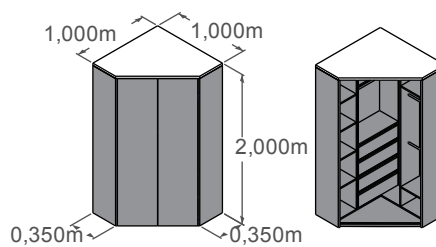

Vestidor 2A4 100x100x200  
2 cossos; portes corraderes; 4 calaixos

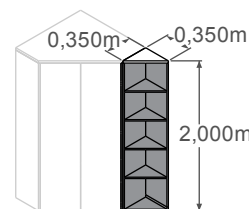

Terminal Dret  Terminal Esquerre

Observacions generals:

Conforme client